

System context diagram

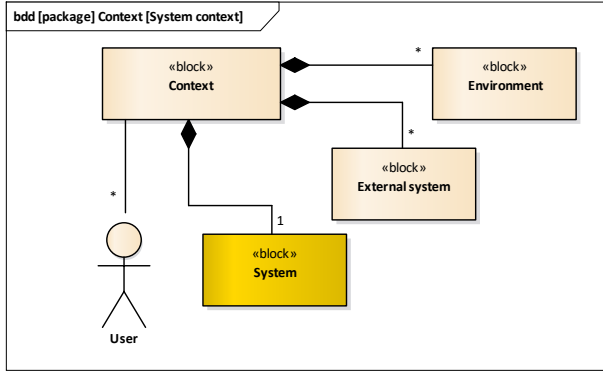

Use case diagram

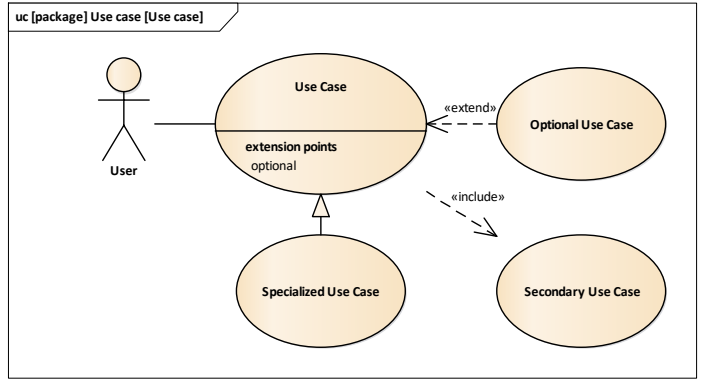

Block definition diagram

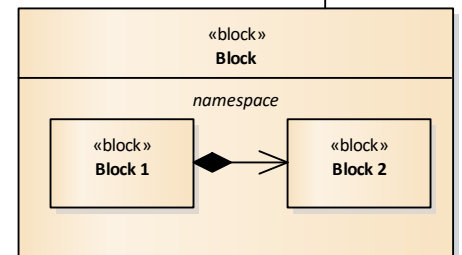
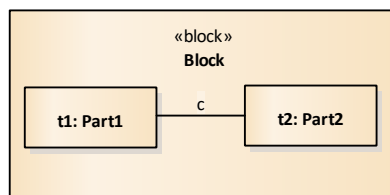
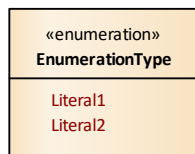
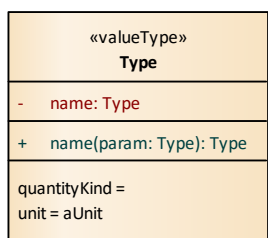
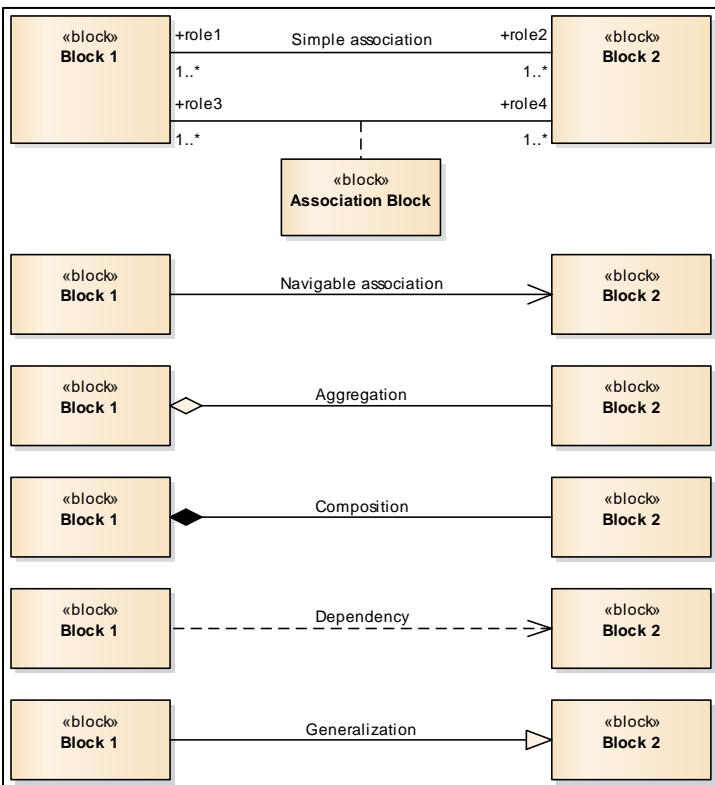
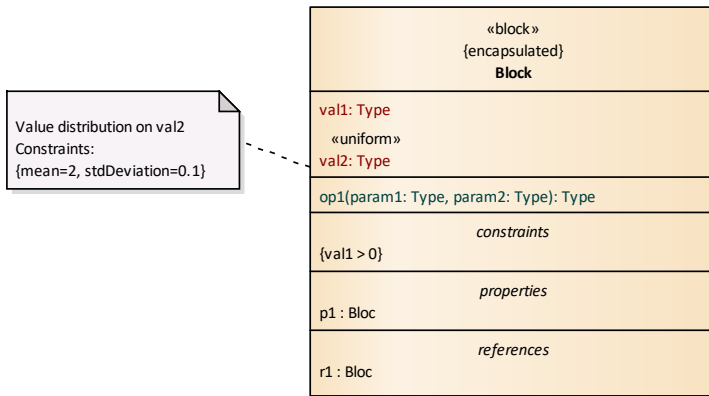

Ports

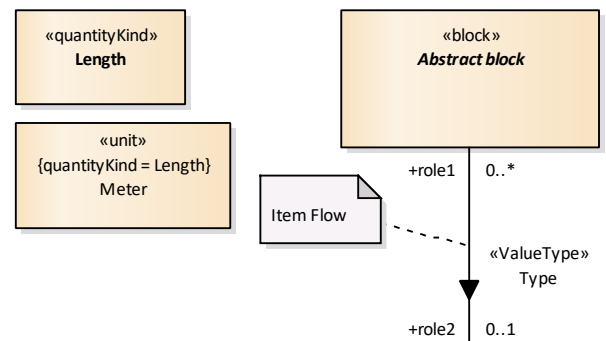
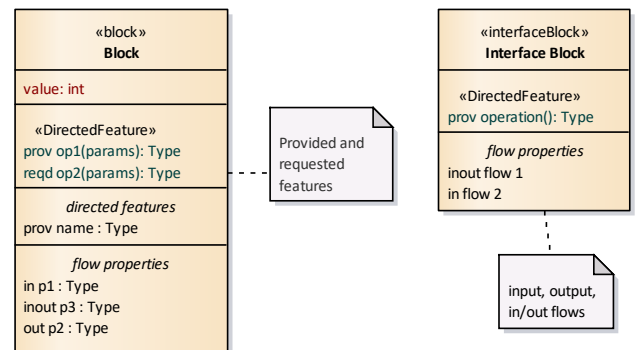
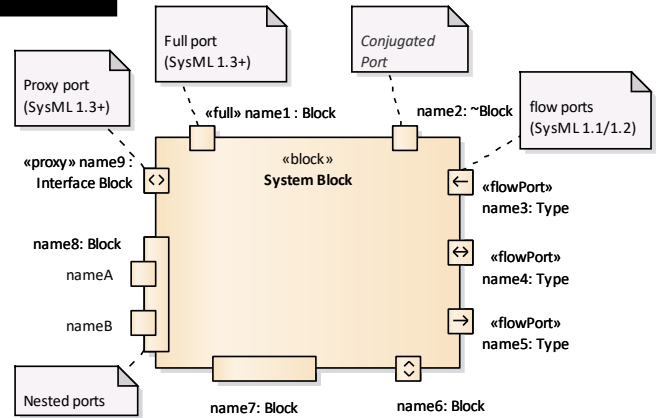

Internal block diagram

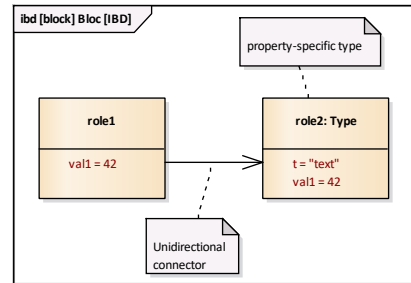
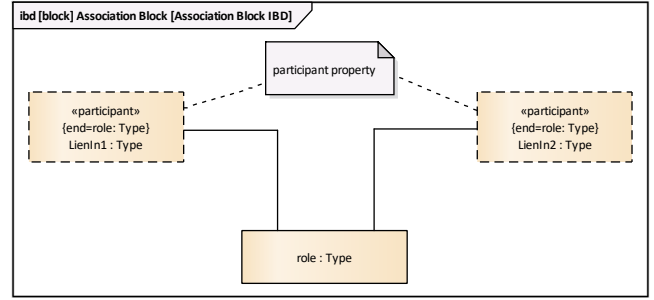
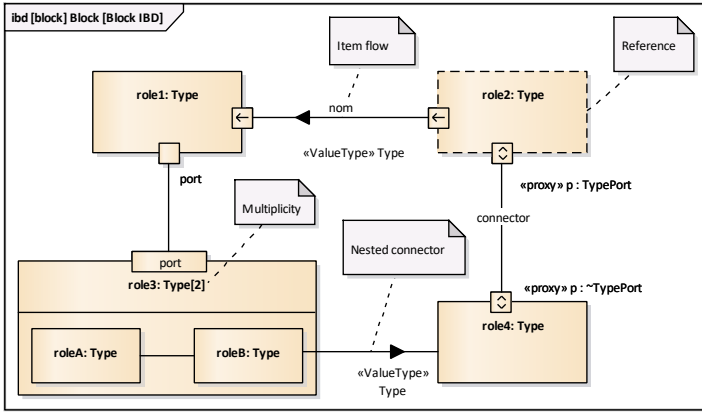

Requirements

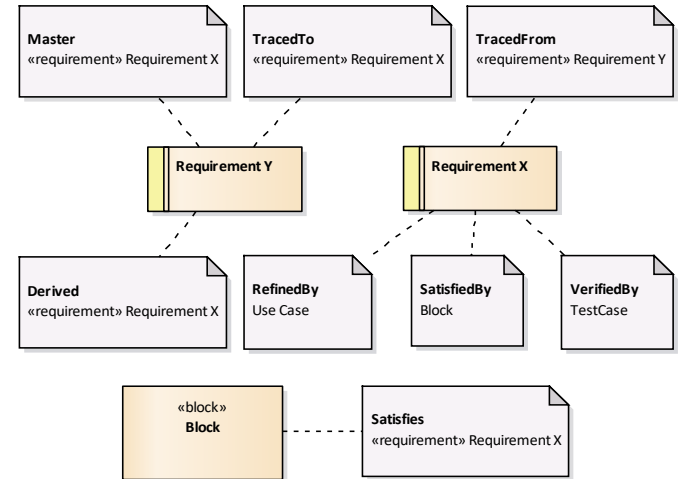
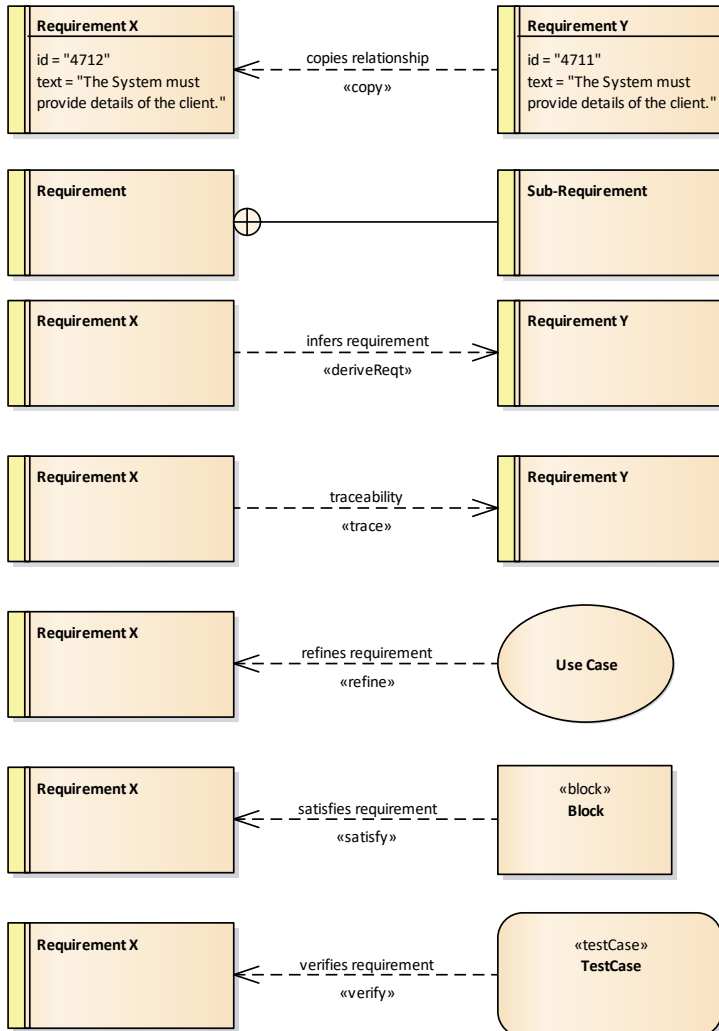

Packages

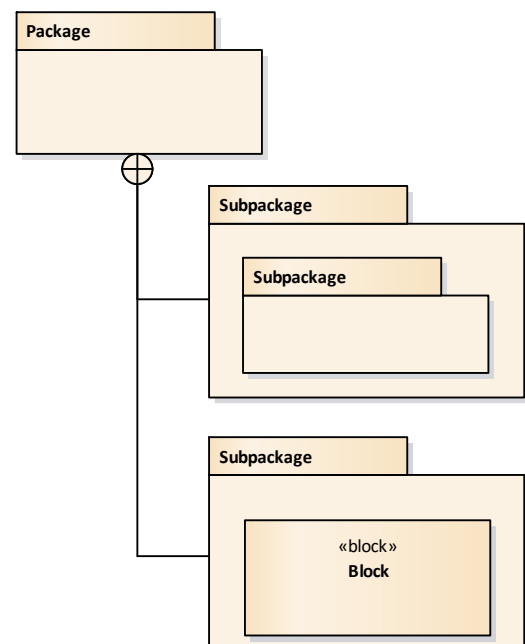

Sequence diagram

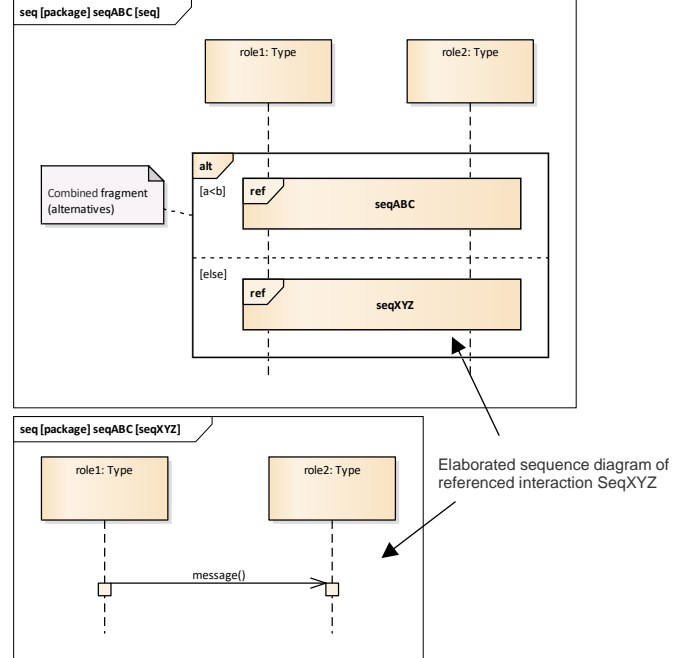
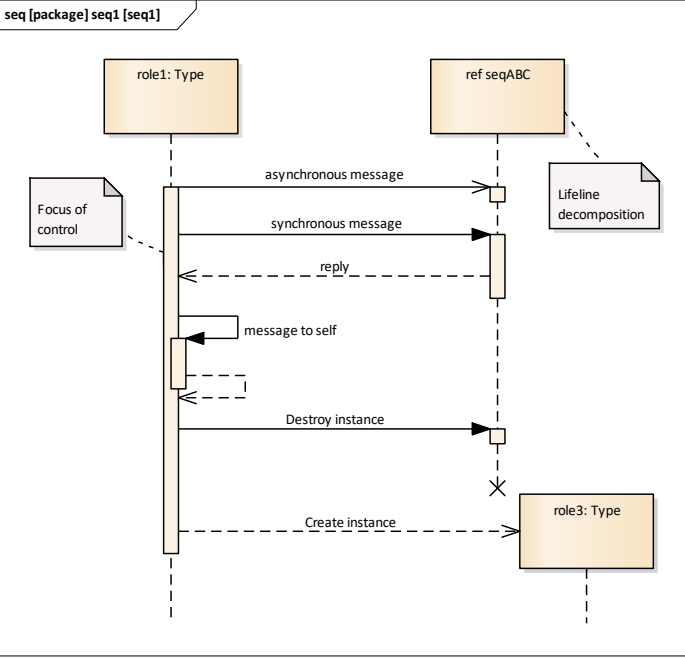

Activity diagram

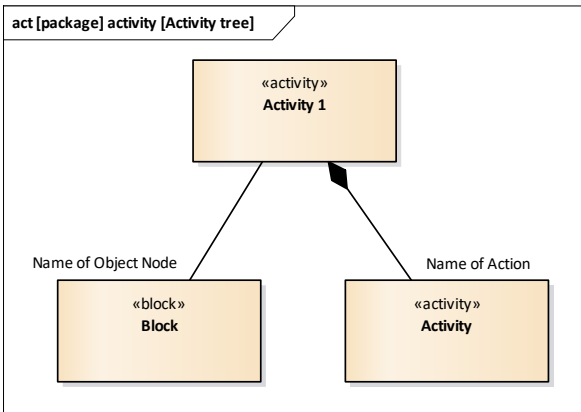
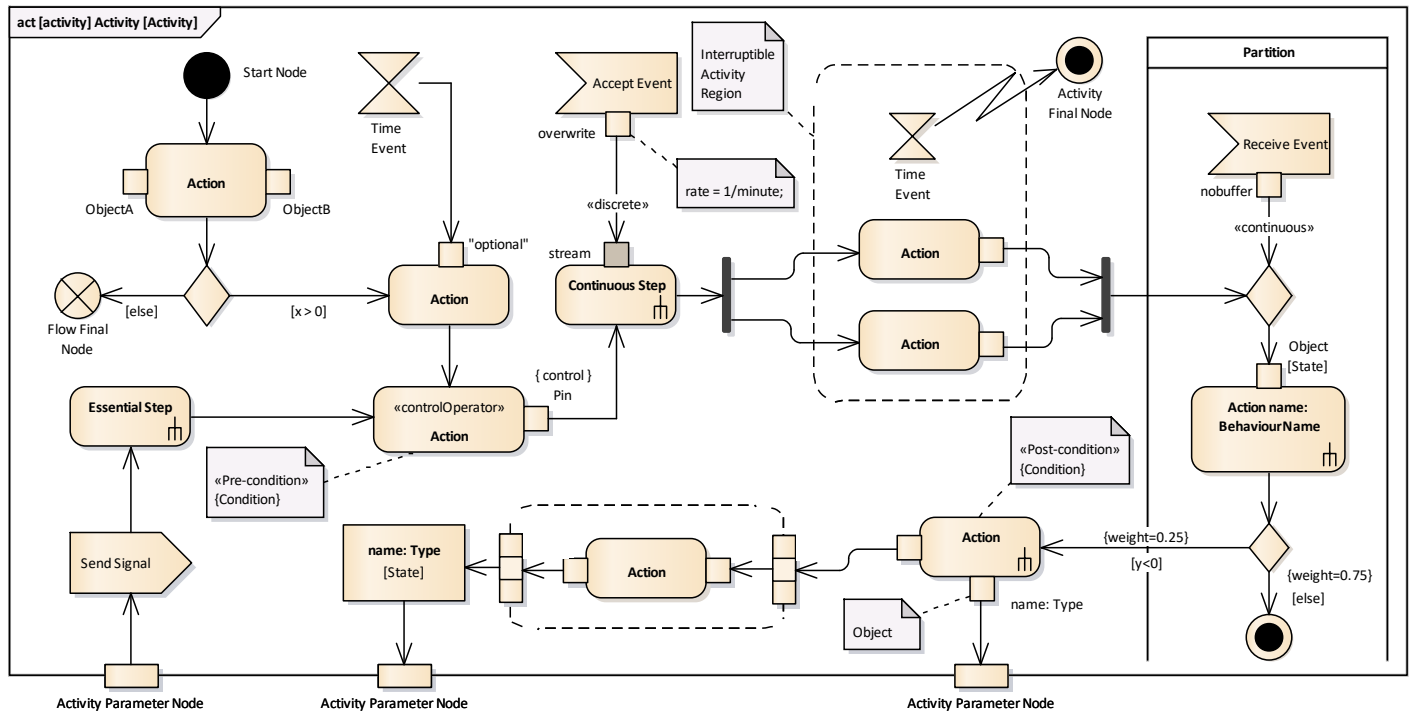

Comments and constraints

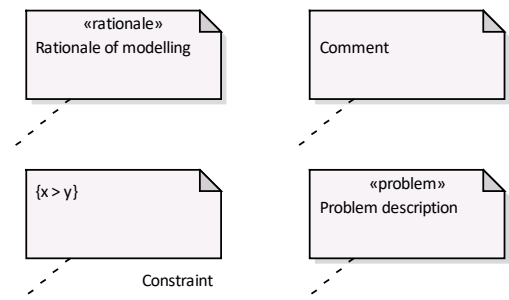

State Machines

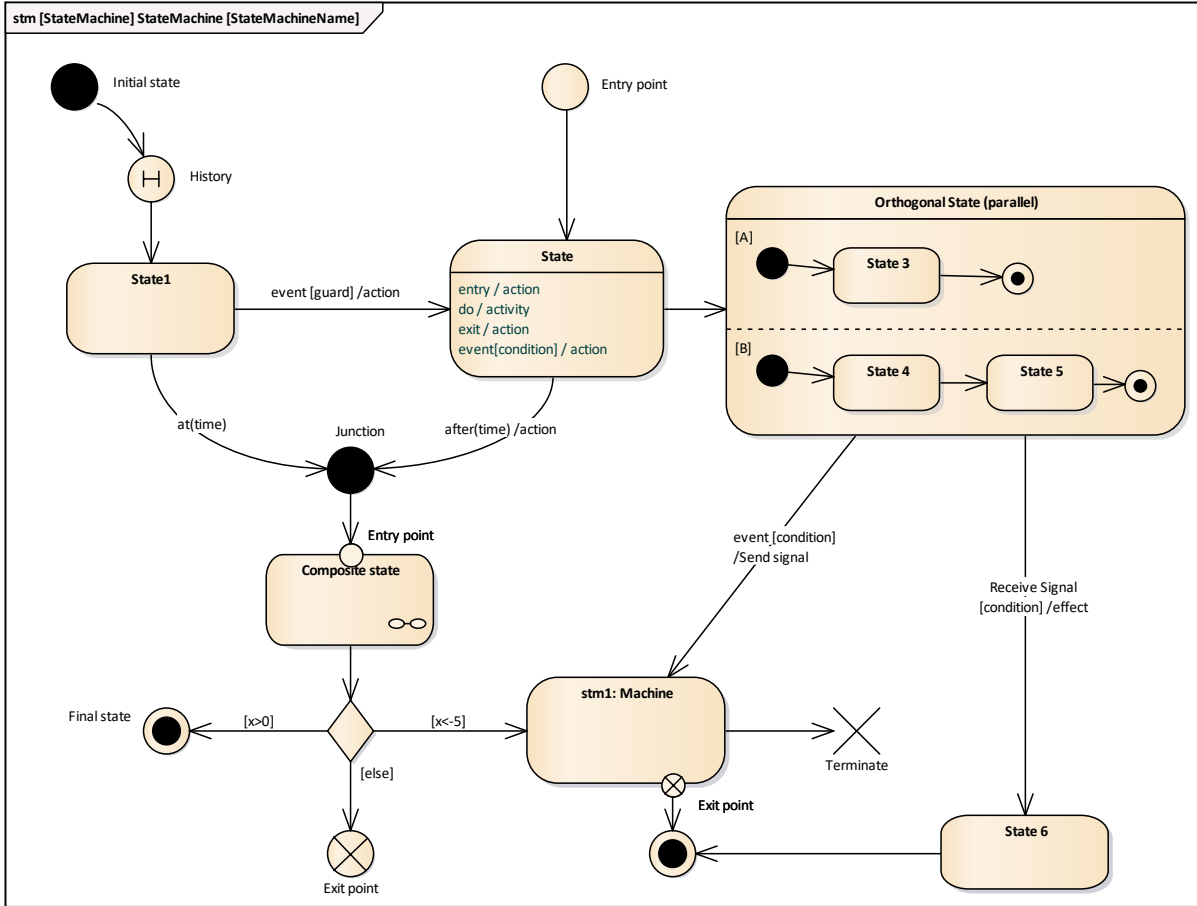

Allocations

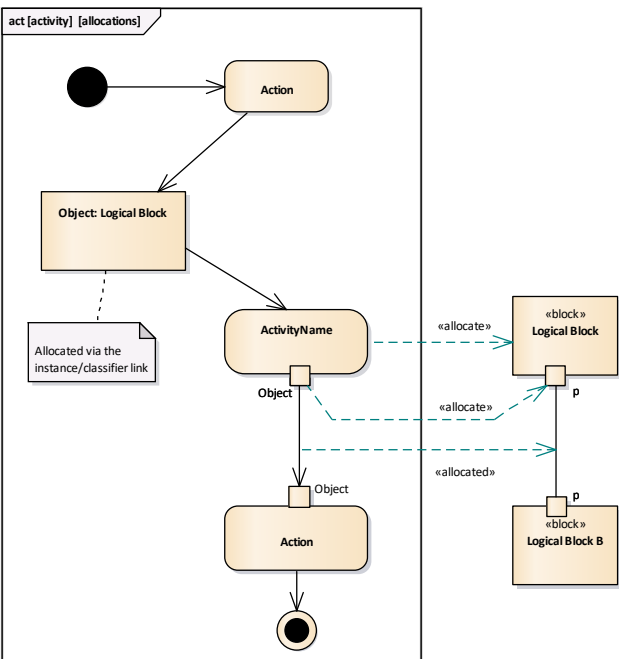
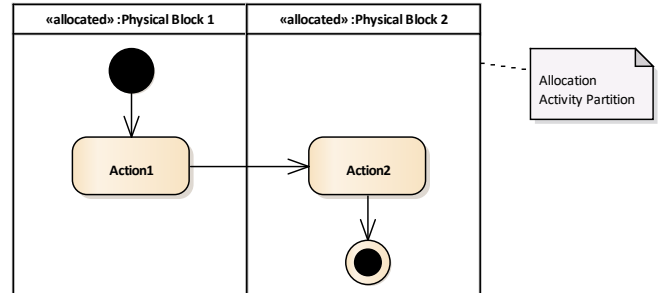
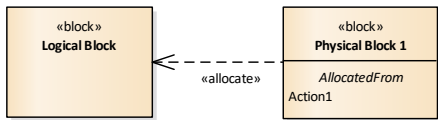

Parametric diagram

